



BALADE DES BLOUSES BLANCHES  
18 avril 1999 - 1 ère Boucle (AV midi)

1

<p>XHENDELESSE</p> <p>RSP 1,8 Km</p> <p>4</p>	<p>Gite à la ferme</p> <p>C.S. BOLLAND</p> <p>1,4 Km</p> <p>8</p>	<p>n°44</p> <p>50m</p> <p>12</p>
<p>HERVE</p> <p>400m</p> <p>3</p>	<p>C.S. BOLLAND</p> <p>RSP 2 Km</p> <p>7</p>	<p>SAREMONT</p> <p>50m</p> <p>11</p>
<p>400m</p> <p>2</p>	<p>HERVE 2</p> <p>1,4 Km</p> <p>6</p>	<p>n°31</p> <p>400m</p> <p>10</p>
<p>Resto LE VERMONT</p> <p>DEPART au parking</p> <p>1</p>	<p>STOP</p> <p>1,1 Km</p> <p>5</p>	<p>Traiteur et Vins</p> <p>500m</p> <p>9</p>



BALADE DES BLOUSES BLANCHES  
18 avril 1999 - 1 ère Boucle (AV midi)

<p>200m</p> <p>16</p>	<p>2,2 Km</p> <p>20</p>	<p>200m</p> <p>24</p>
<p>200m</p> <p>15</p>	<p>300m</p> <p>19</p>	<p>800m</p> <p>23</p>
<p>1,2 Km</p> <p>14</p>	<p>1,7 Km</p> <p>18</p>	<p>2,3 Km</p> <p>22</p>
<p>50m</p> <p>13</p>	<p>500m</p> <p>17</p>	<p>800m</p> <p>21</p>



BALADE DES BLOUSES BLANCHES  
18 avril 1999 - 1 ère Boucle (AV midi)

3

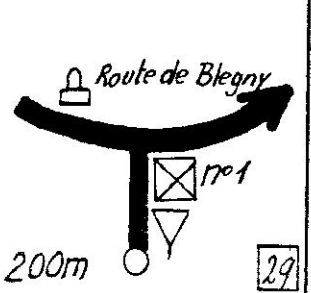
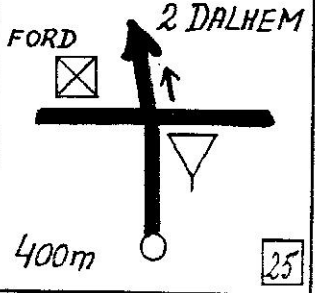
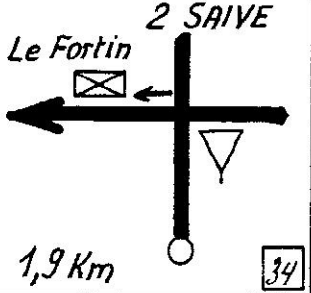
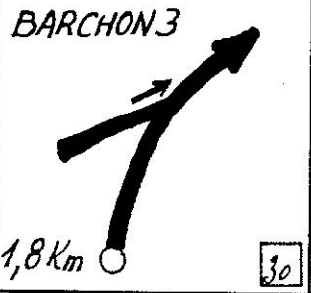
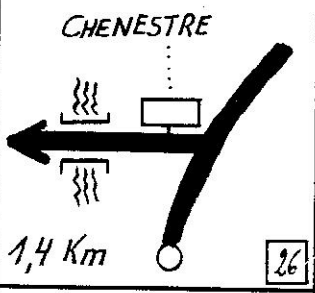
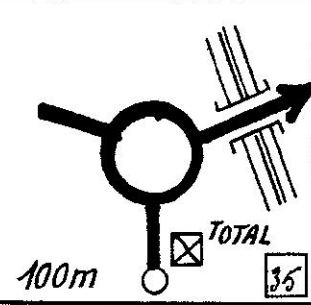
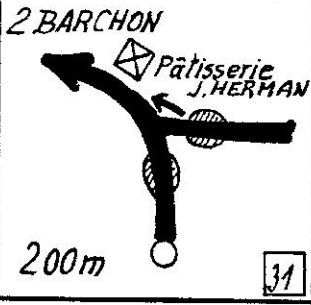
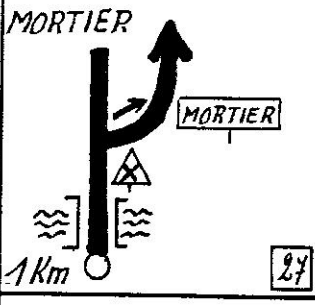
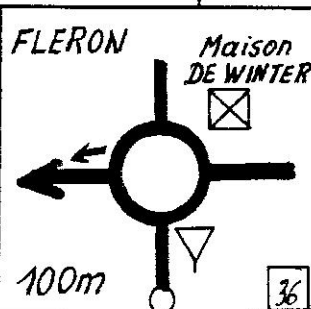
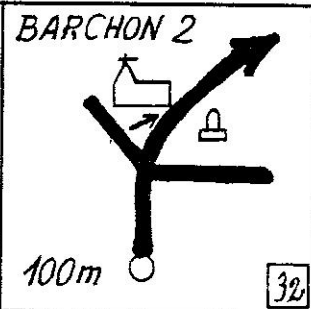
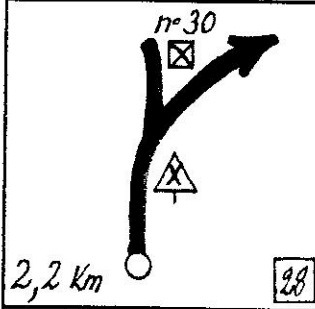



BALADE DES BLOUSES BLANCHES  
18 avril 1999 - 1 ère Boucle (AV midi)

4

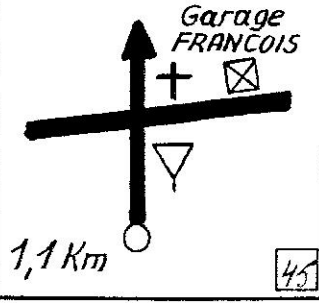
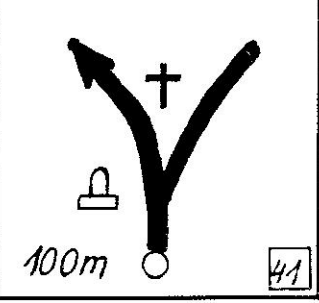
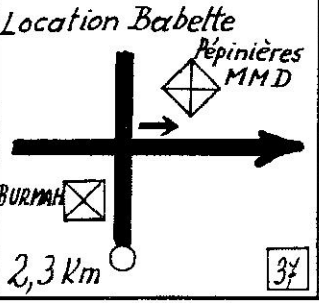
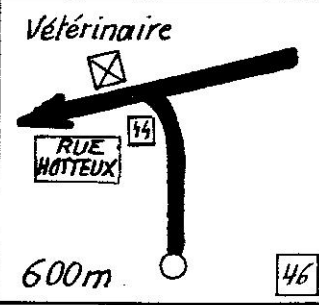
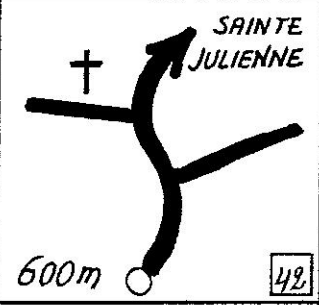
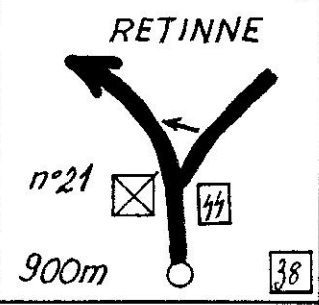
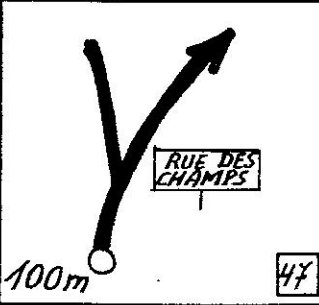
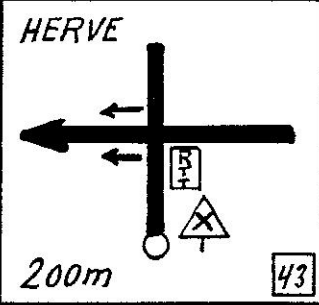
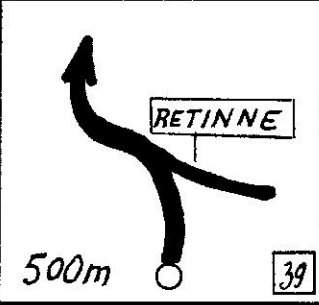
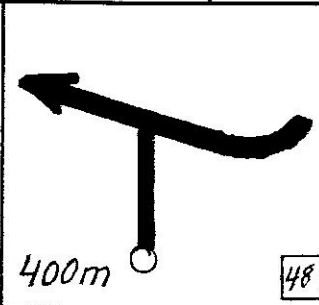
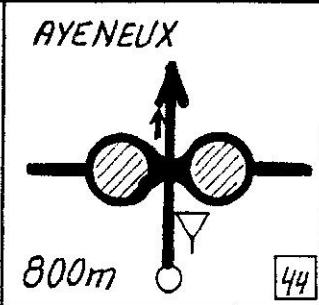
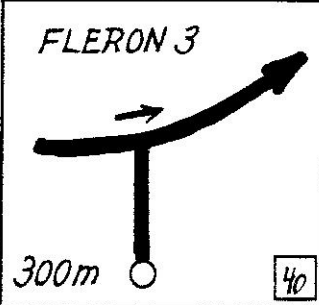



BALADE DES BLOUSES BLANCHES  
18 avril 1999 - 1 ère Boucle (AV midi)

5

<p>BUS Bulle verte 900m</p> <p>52</p>	<p>SPA 22 1,6 Km</p> <p>56</p>	<p>LINCE FAYS BUS 1,5 Km</p> <p>60</p>
<p>n°73 500m</p> <p>51</p>	<p>Parc à containers SIEMENS 4,7 Km</p> <p>55</p>	<p>Hôtel Le Normandie 500m</p> <p>59</p>
<p>44 200m</p> <p>50</p>	<p>FORET 900m</p> <p>54</p>	<p>2,3 Km</p> <p>58</p>
<p>44 100m</p> <p>49</p>	<p>HANSEZ 1,7 Km</p> <p>53</p>	<p>LA GEISHA STOP 3,1 Km</p> <p>57</p>



BALADE DES BLOUSES BLANCHES  
18 avril 1999 - 1 ère Boucle (AV midi)

6

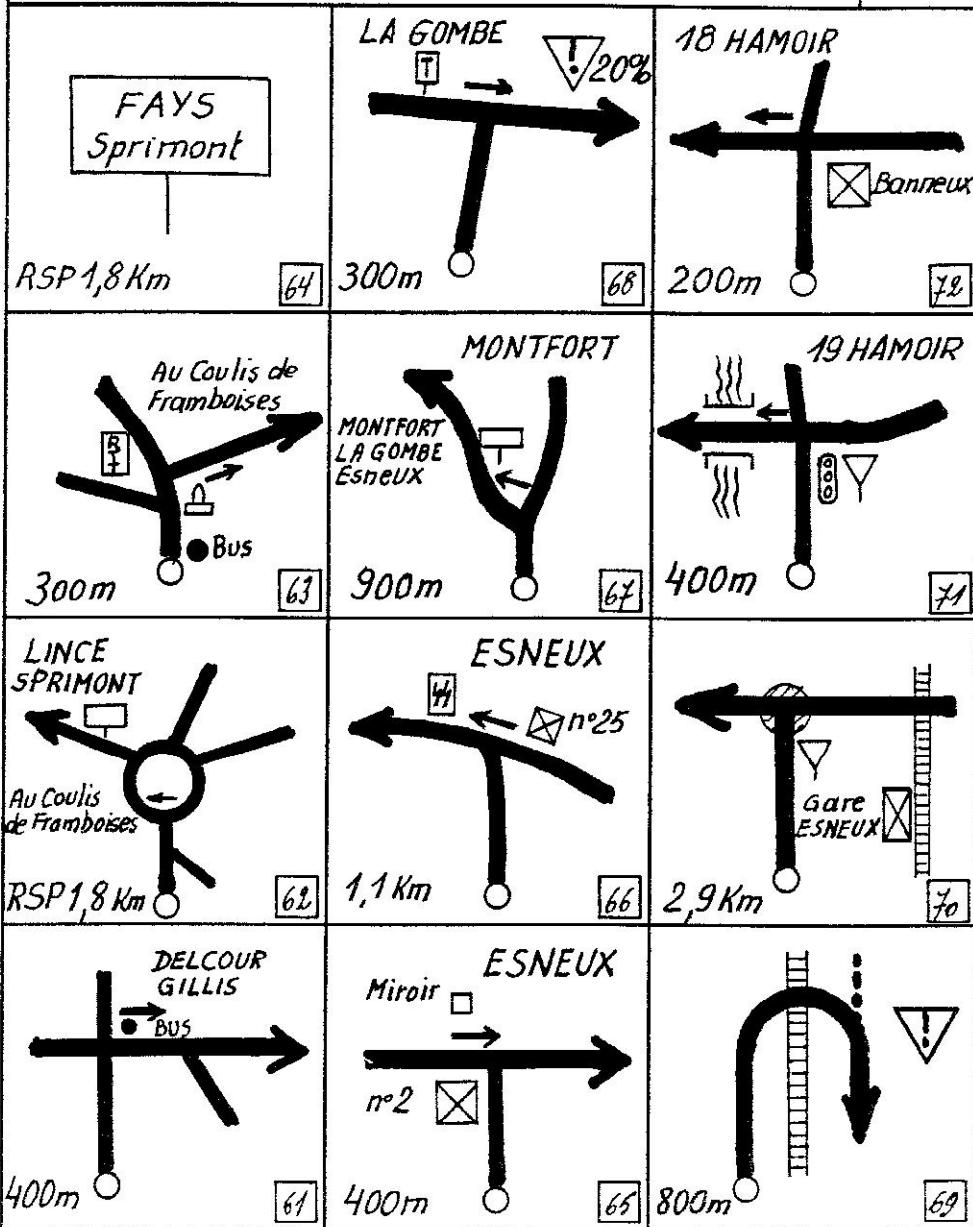



BALADE DES BLOUSES BLANCHES  
18 avril 1999 - 1 ère Boucle (AV midi)

7

REPAS DE MIDI  
à la salle de  
UNION MOSANE SPORTIVE  
tél. 04-380.11.58



74

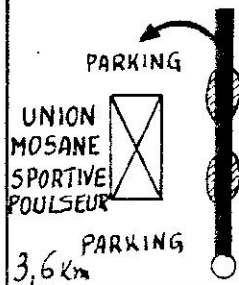

73



BALADE DES BLOUSES BLANCHES  
18 avril 1999 - 2 ème Boucle (AP midi)

8

<p>RSP par HESTREUX 1 Km</p> <p>4</p>	<p>2 MOULIN</p> <p>900m</p> <p>8</p>	<p>700m</p> <p>10</p>
<p>LIMONT 2</p> <p>Miroir</p> <p>RSP 3,8 Km</p> <p>3</p>	<p>1 TAVIER</p> <p>A TULTAY</p> <p>1,4 Km</p> <p>7</p>	<p>TAVIER Anthignes</p> <p>200m</p> <p>11</p>
<p>5 HODY</p> <p>1,1 Km</p> <p>2</p>	<p>TAVIER 3</p> <p>Bus</p> <p>700m</p> <p>6</p>	<p>FRAITURE 3</p> <p>Miroir</p> <p>n°80</p> <p>300m</p> <p>10</p>
<p>DEPART</p> <p>UNION MOSANE SPORTIVE</p> <p>1</p>	<p>4 TAVIER</p> <p>5</p>	<p>MOULIN</p> <p>500m</p> <p>9</p>





BALADE DES BLOUSES BLANCHES  
18 avril 1999 - 2 ème Boucle (AP midi)

9

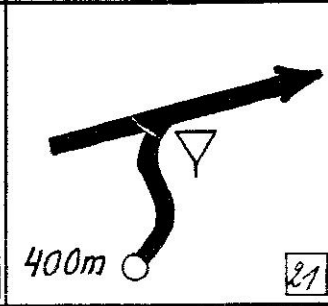
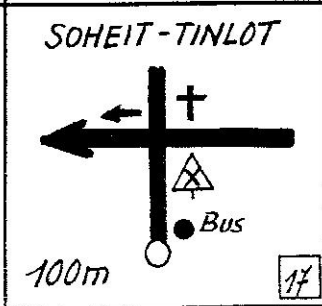
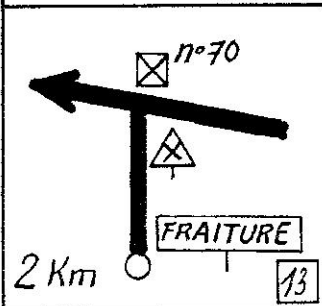
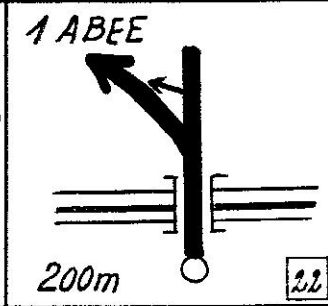
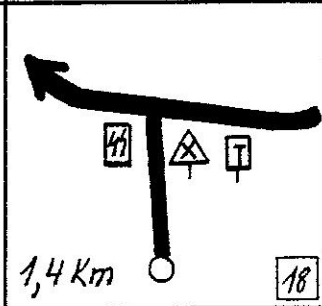
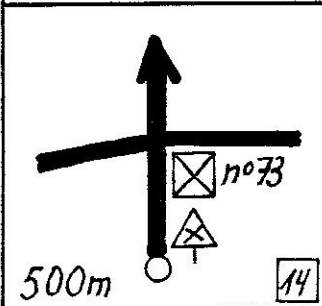
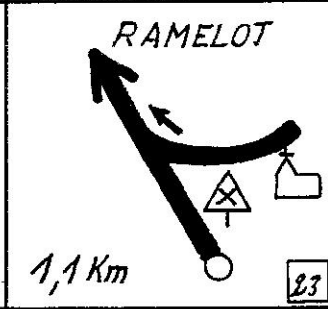
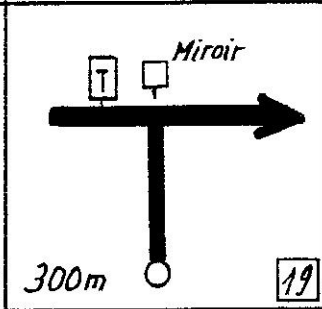
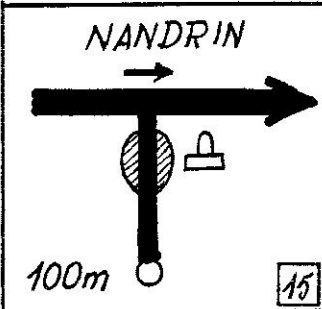
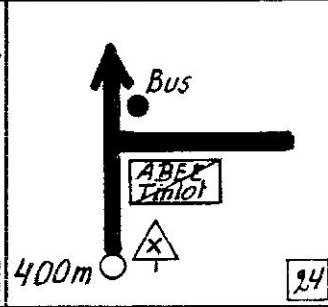
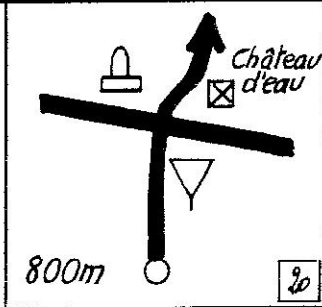
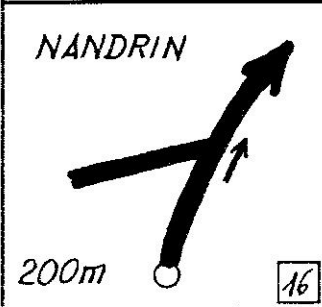



BALADE DES BLOUSES BLANCHES  
18 avril 1999 - 2 ème Boucle (AP midi)

10

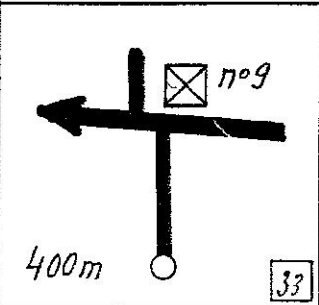
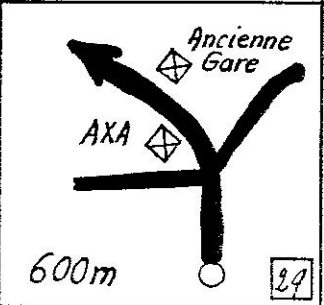
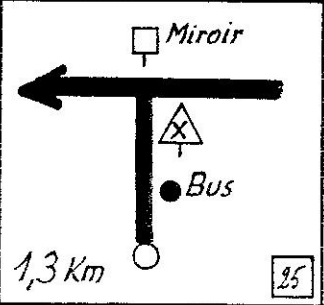
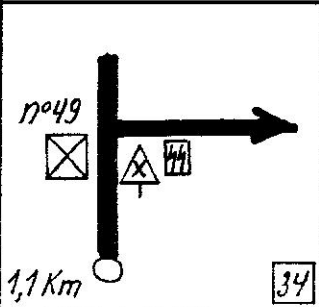
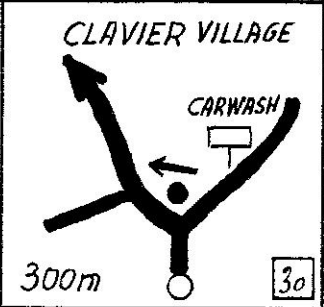
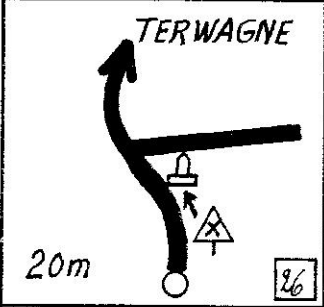
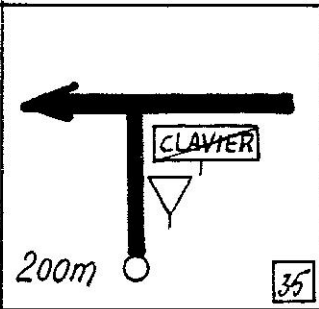
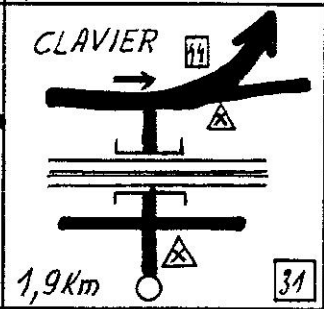
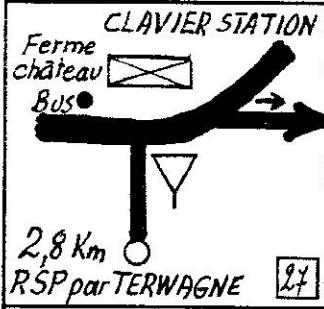
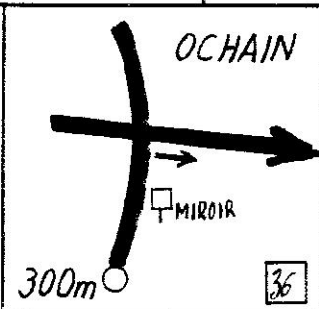
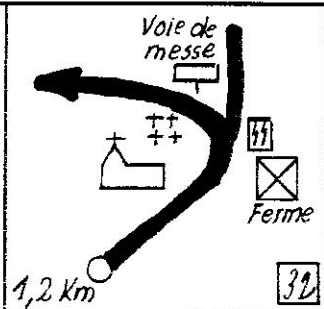
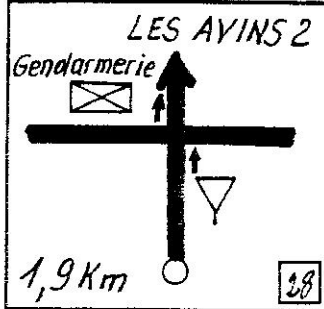



BALADE DES BLOUSES BLANCHES  
18 avril 1999 - 2ème Boucle (AP midi)

11

<p>2,5 Km</p> <p>40</p>	<p>50m</p> <p>44</p>	<p>TAVIER</p> <p>200m</p> <p>48</p>
<p>50m</p> <p>39</p>	<p>Arrêt graissage au CAFE DES SPORTS Marc PARMENTIER Grand'route, 58 4590 WARZEE tél. 086-36.62.79</p> <p>43</p>	<p>2 Km</p> <p>47</p>
<p>200m</p> <p>38</p>	<p>OUFFET 4</p> <p>1 Km</p> <p>42</p>	<p>1,1 Km</p> <p>46</p>
<p>700m</p> <p>37</p>	<p>700m</p> <p>41</p>	<p>300m</p> <p>45</p>



BALADE DES BLOUSES BLANCHES  
18 avril 1999 - 2<sup>ème</sup> Boucle (AP midi)

12

<p>LIEGE 27</p> <p>1,2 Km <span style="border: 1px solid black; padding: 2px;">52</span></p>	<p>50m <span style="border: 1px solid black; padding: 2px;">56</span></p>	<p>Place de Comblain</p> <p>Café des Grottes 200m <span style="border: 1px solid black; padding: 2px;">60</span></p>
<p>HODY</p> <p>Miroir Route romantique 900m <span style="border: 1px solid black; padding: 2px;">51</span></p>	<p>44 400m <span style="border: 1px solid black; padding: 2px;">55</span></p>	<p>2,3 Km <span style="border: 1px solid black; padding: 2px;">59</span></p>
<p>Route romantique XHOS 900m <span style="border: 1px solid black; padding: 2px;">50</span></p>	<p>POULSEUR 6</p> <p>44 1,1 Km <span style="border: 1px solid black; padding: 2px;">54</span></p>	<p>MONT COMBLAIN</p> <p>Route romantique 1,1 Km <span style="border: 1px solid black; padding: 2px;">58</span></p>
<p>XHOS</p> <p>Miroir Route romantique 1,7 Km <span style="border: 1px solid black; padding: 2px;">49</span></p>	<p>ANTHISNE 2</p> <p>Route romantique 1,2 Km <span style="border: 1px solid black; padding: 2px;">53</span></p>	<p>LA COUPOLE 1 Km <span style="border: 1px solid black; padding: 2px;">57</span></p>



BALADE DES BLOUSES BLANCHES  
18 avril 1999 - 2<sup>ème</sup> Boucle (AP midi)

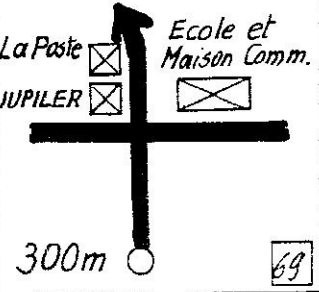
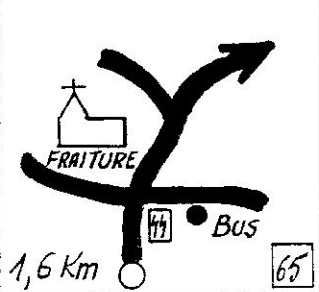
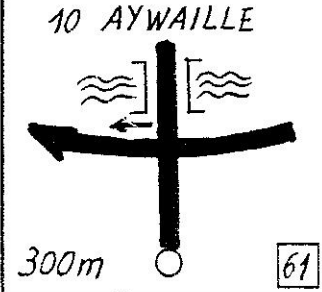
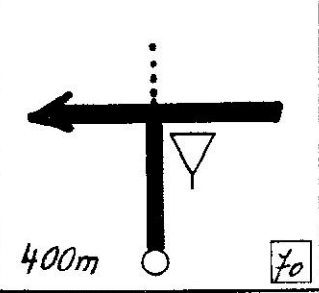
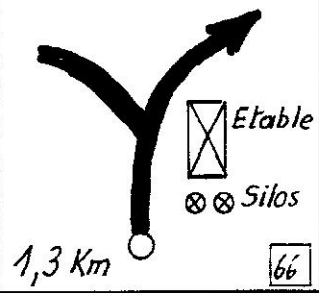
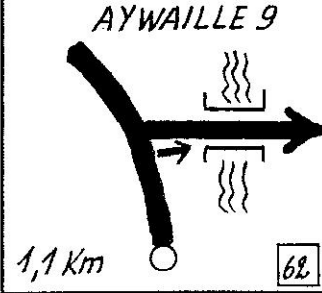
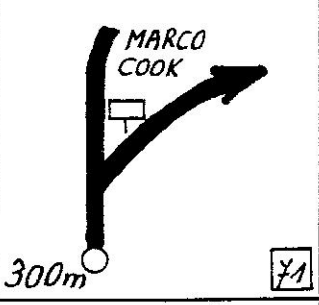
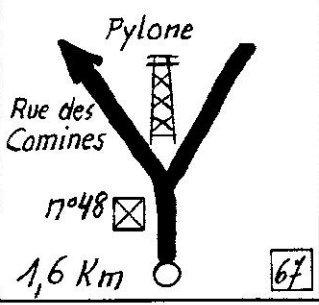
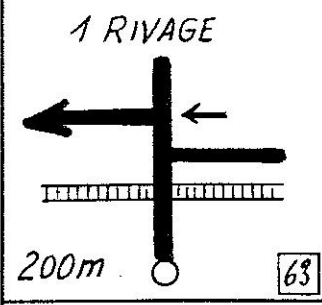
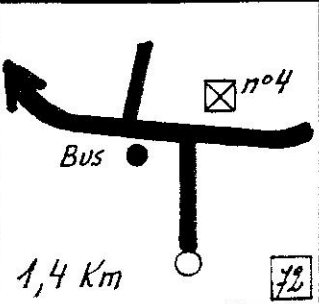
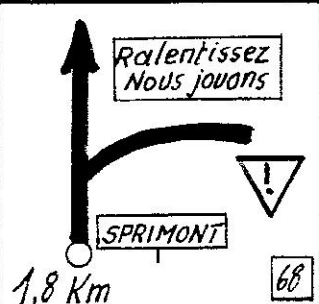
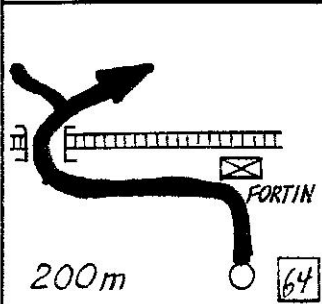



BALADE DES BLOUSES BLANCHES  
18 avril 1999 - 2ème Boucle (AP midi)

14

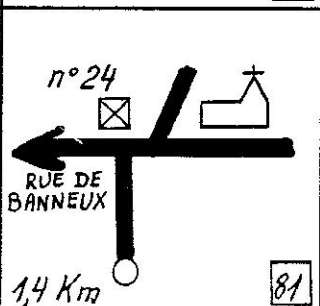
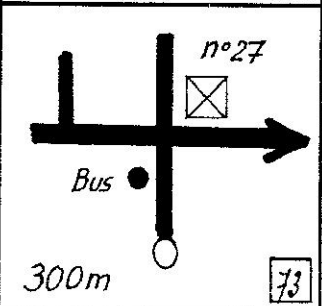
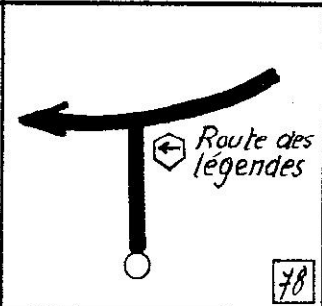
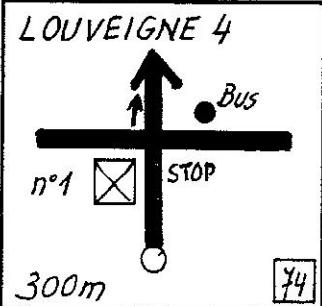
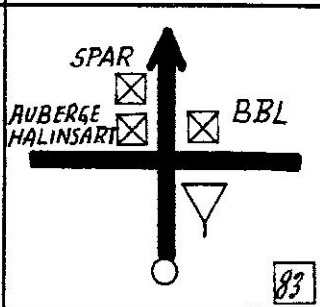
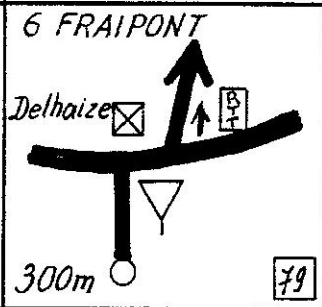
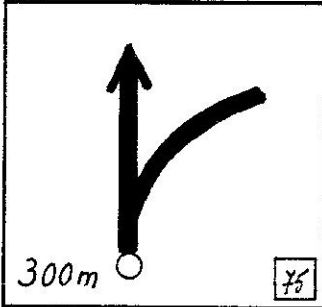
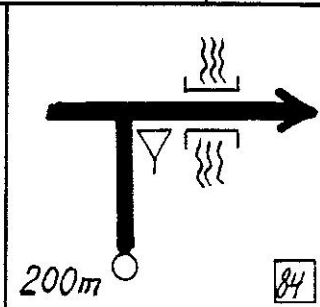
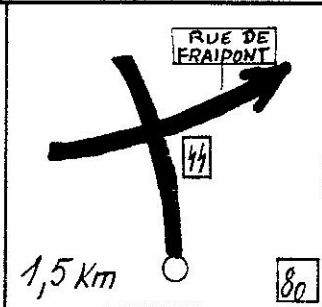
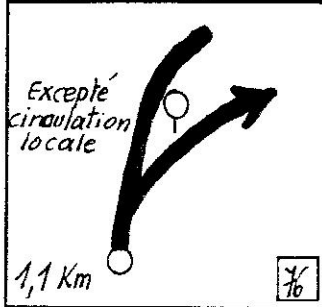



BALADE DES BLOUSES BLANCHES  
18 avril 1999 - 2ème Boucle (AP midi)

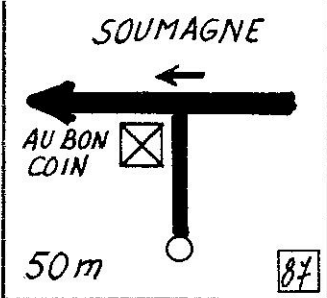
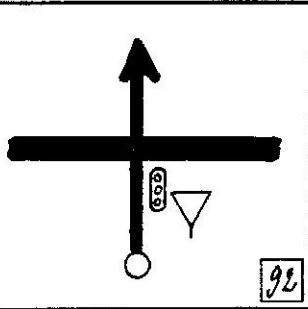
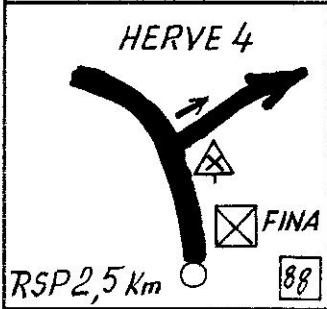

Nous espérons que vous avez passé une journée agréable à découvrir certains coins méconnus de notre belle région. Nous vous remercions très chaleureusement pour votre participation et vous disons .... à la prochaine fois.

Les organisateurs.

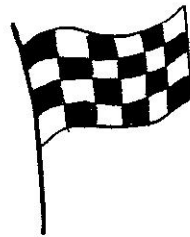
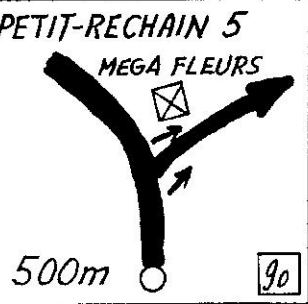
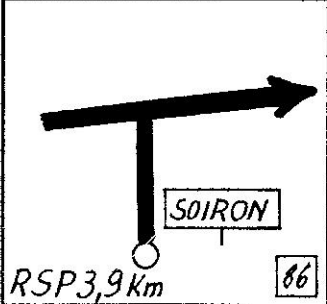

94

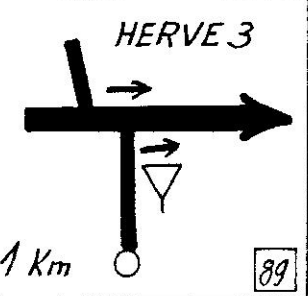

Resto LE VERMONT



Parking

400m

93